

General description

The E2xFxW3 30W family of switch mode power supplies delivers typically 30W output and features wide-range input (90-264V), small size and light weight.

The units are available in EU, UK, US, Australia, changeable plug and desktop housing to fit major markets, others can be tooled on request.

Output voltage is fixed with a tolerance of $\pm 3\%$ on PCB (1% tolerance and current regulation on request). Output voltages are available between 5V and 24V DC. Secondary plug is available in different forms. The power supply is for indoor use only.

Features

- **EuP Tier II conform**
- **Medical approved according IEC60601-1 3rd edition - fulfils patient contact requirements to maximum 24W output power**
- Wide input range (90-264V)
- Output voltage fixed (5-24VDC)
- Output voltage stability $\pm 3\%$ at PCB (1% on request)
- Output power 30W
- Protection class II
- Europe, UK, US, Australia, Desktop, Changeable plug (other on request)
- Secondary plug customer specific possible
- Manufacturing according to ISO 9001
- Short circuit proof

The power supply is available for 3 different application areas

- Information technology equipment area
- Household device area
- Medical electrical equipment area

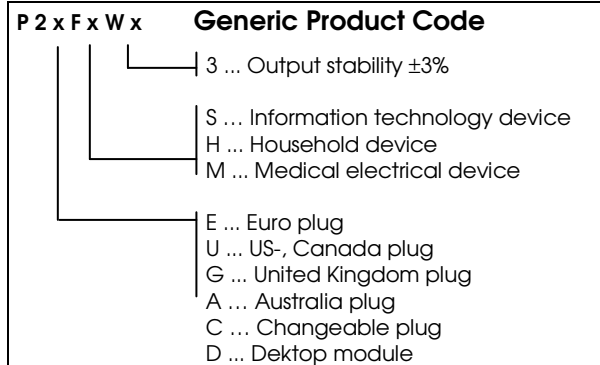

Dimensions	Length	Width	Height	
30W Wall Plug IN Housing	105	42	37	mm
Desktop Housing	110	54	38	mm

Input Parameter	Key	Min	Typ	Max	Unit
Input voltage	U_1	90		264	V
Input current	I_1	3	300	700	mA
Input frequency	f_1	47	50	63	Hz
Op. Temperature	T	0		40	$^{\circ}\text{C}$
Efficiency	η		87		%
		According EuP Tier II			





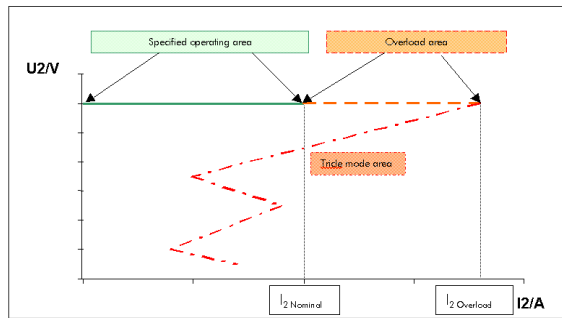



























Output Parameter	Key	Min	Typ	Max	Unit
Output Power	P_2			30	W
Output Voltage	U_2	5		24	V
Output current	I_2			3	A
Ripple voltage	U_{RMS}			50	mV RMS
Output voltage tolerance at PCB	T_{U_2}			3	%
Output voltage tolerance with EGSTON standard cable 1,5m/0,5mm ²	T_{U_2}			5-12,9V: +3/-10 13-24V: +3/-5	%

Typical output chart



Test standards and approvals

Test standards	
EN 60950 UL 1310 EN 61000-6-1 EN 55022 EN 55011 EN 55014-1	Information technology equipment
EN 60335 EN 61558 UL 1310 EN 61000-6-1 EN 55022 EN 55011 EN 55014-1	Household devices
EN 60601-1 UL 60601-1 EN 60601-1-2 EN 61000-6-1 EN 55022 EN 55011 EN 55014-1	Medical electrical equipment up to max. 24W output power

Housing	Approvals		
	Information technology equipment	Household devices	Medical electrical equipment
EU, UK:	 	 	 
US, Canada:	 	 	 
Desktop	   Australian Government approval	   Australian Government approval	   Australian Government approval
Australia:	 Australian Government approval	 Australian Government approval	 Australian Government approval
Change able plug:	   Australian Government approval	   Australian Government approval	   Australian Government approval

Housing Dimension

Euro Housing:

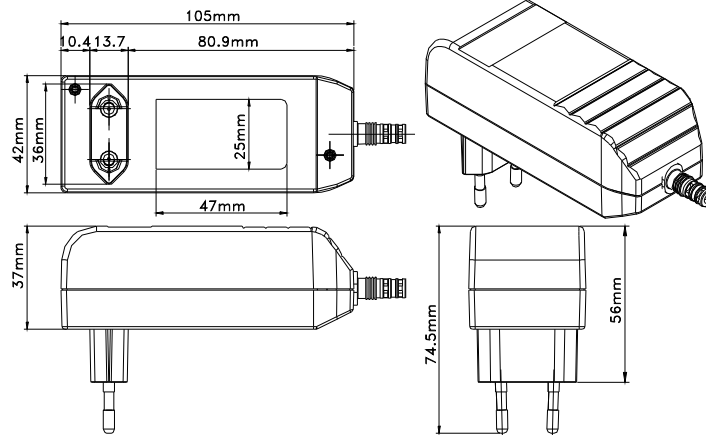

US Housing:

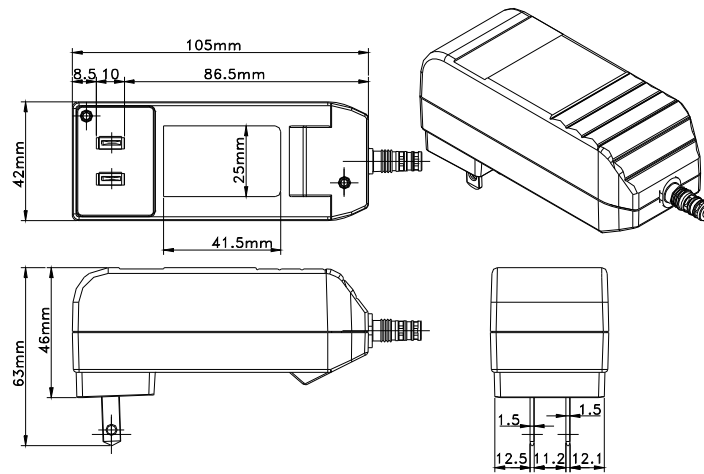

UK Housing:

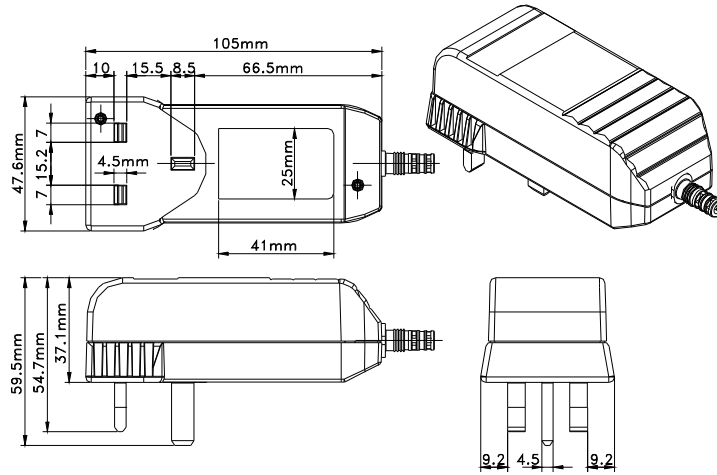

Desktop Housing with IEC 320 C14 primary plug:

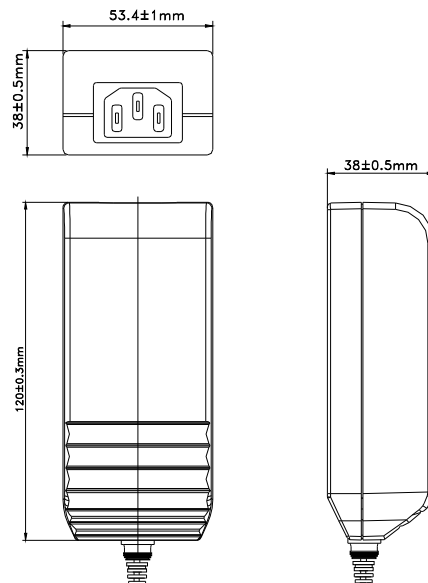

Desktop Housing with IEC 320 C8 primary plug:

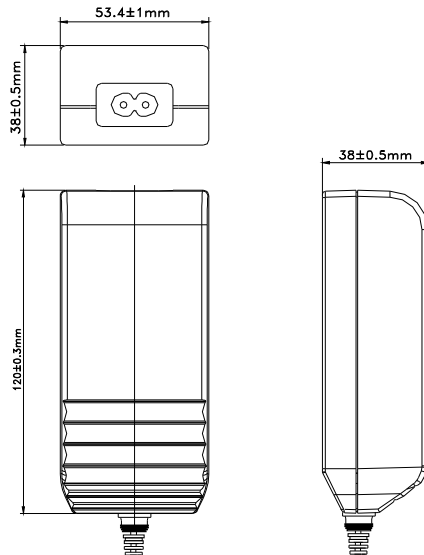

Australia Housing:

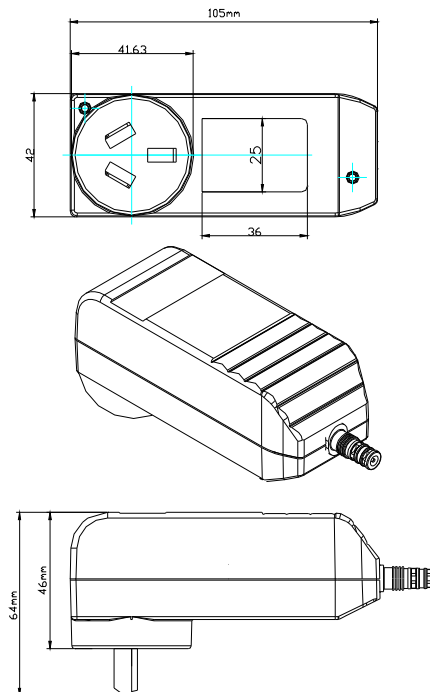

Changeable plug Housing:

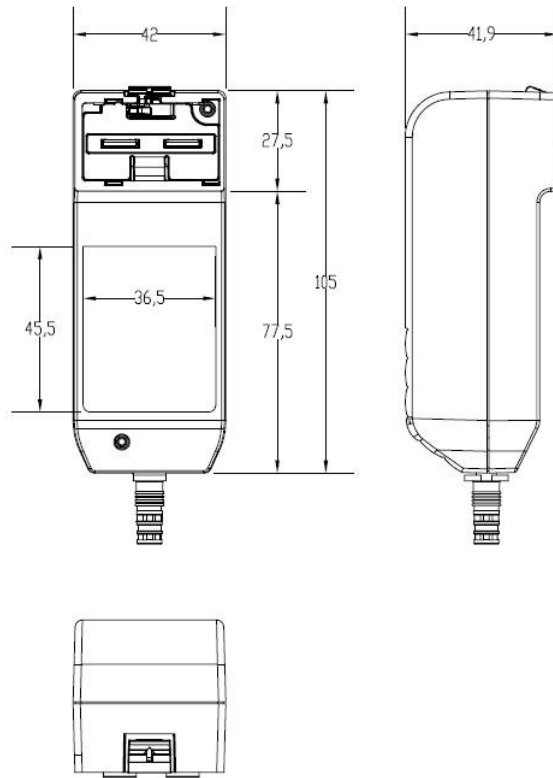

Changeable plugs:

EU Plug according: EN50075

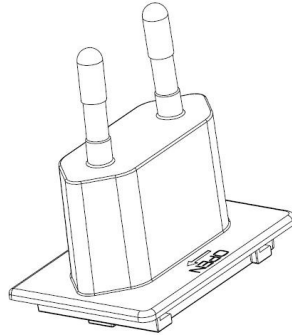

US Plug according: UL1310

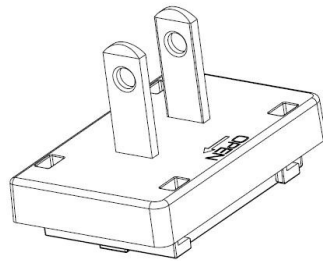

UK Plug according: BS1363

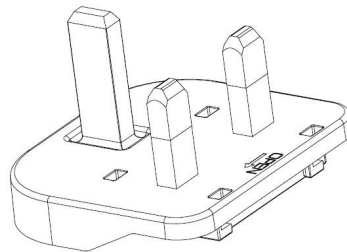

Australia Plug according: AS/NZS 3112

